

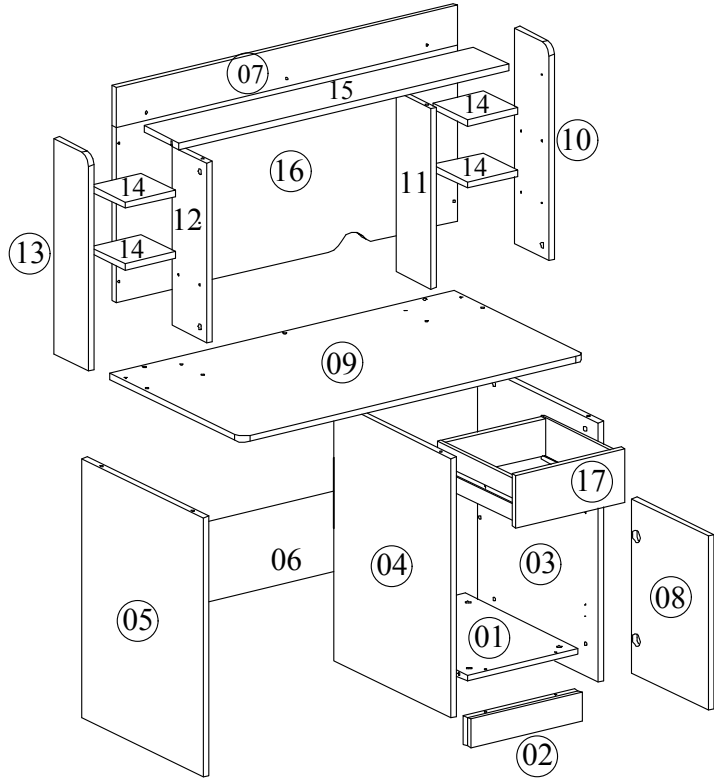

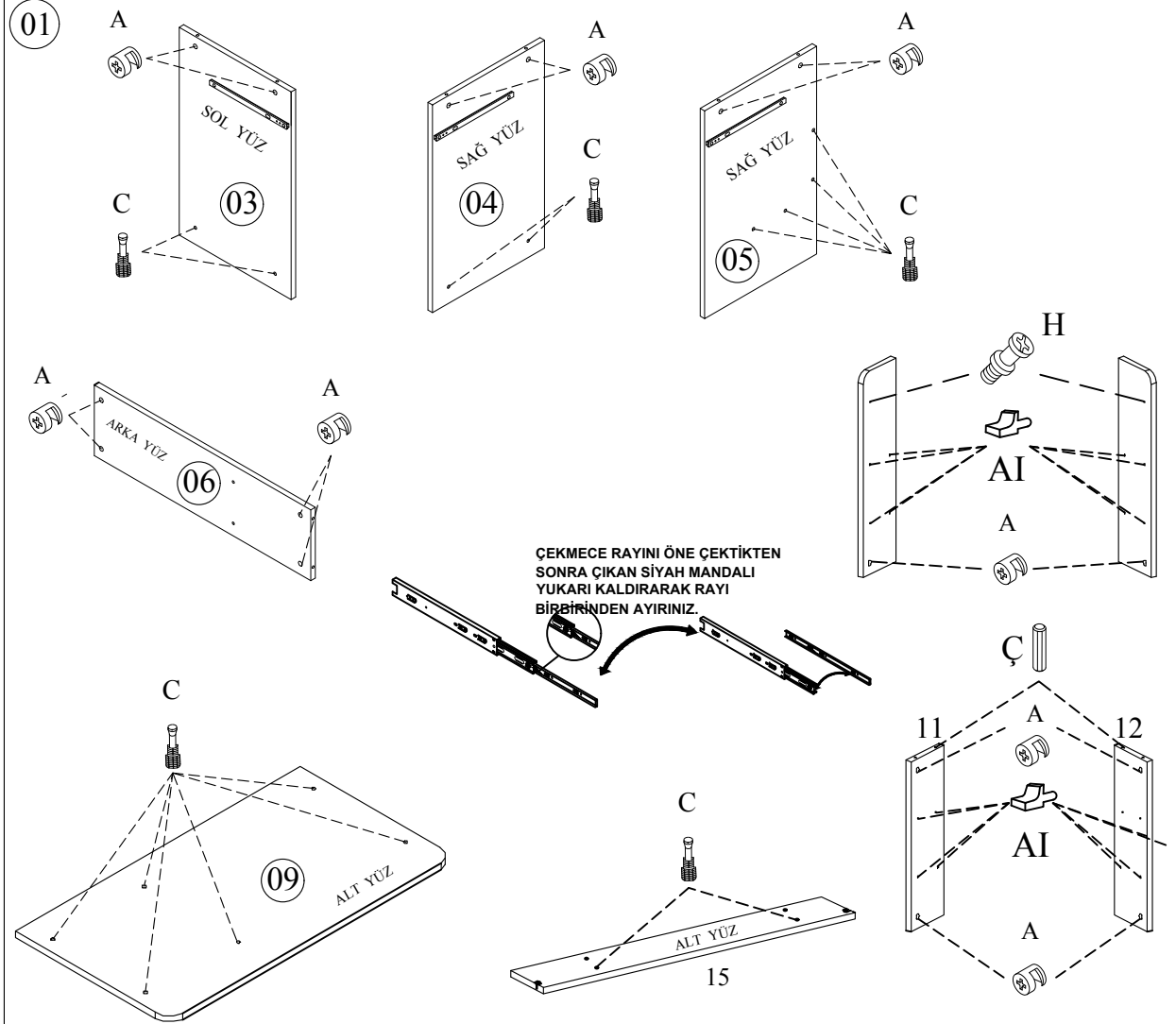







- Yedek Parçaya ihtiyaç duyduğunuz takdirde, lütfen montaj klavuzunda gösterilmiş olan Parça kodunu belirtiniz.
- WHEN ORDERING EXTRA PARTS , DO NOT FORGET TO MENTION PART CODE



- |                                      |                              |
|--------------------------------------|------------------------------|
| 01 - ALT MODÜL ALT TABLA             | 12 - ÜST MODÜL SOL YAN DİKME |
| 02 - BİRLEŞİK BAZA                   | 13 - ÜST MODÜL SOL YAN TABLA |
| 03 - ALT MODÜL SAĞ YAN TABLA         | 14 - ÜST MODÜL SEYYAR RAF    |
| 04 - ALT MODÜL ORTA DİKME            | 15 - ÜST MODÜL ÜST TABLA     |
| 05 - ALT MODÜL SOL YAN TABLA         | 16 - ÜST MODÜL ARKA PANO     |
| 06 - ALT MODÜL ARKA BAĞLANTI PARÇASI | 17 - ALT MODÜL ÇEKMECE ÖNÜ   |
| 07 - ÜST TAC                         | 18 - ÇEKMECE ARKA TABLA      |
| 08 - ALT MODÜL KAPAK                 | 19 - ÇEKMECE SAĞ YAN         |
| 09 - ALT MODÜL ÜST TABLA             | 20 - ÇEKMECE SOL YAN         |
| 10 - ÜST MODÜL SAĞ YAN TABLA         | 21 - ÇEKMECE ALTI            |
| 11 - ÜST MODÜL SAĞ YAN DİKME         |                              |







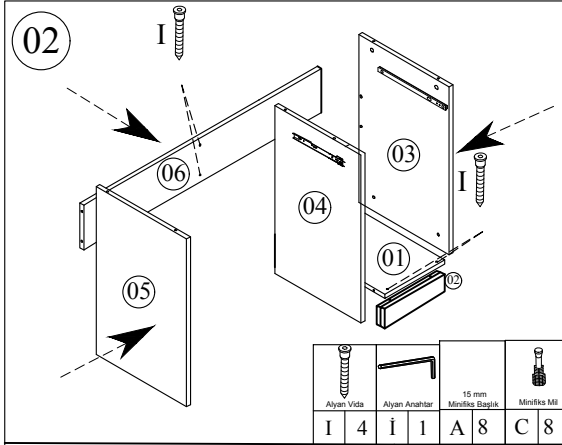

																					
AB	2	S	2	BH	2	A	18	H	2	C	20	Ç	2	I	2	İ	1	AG	4	AI	1

# MONTAJ TALİMATI

MODEL ADI	FORMULA-RALLY GENÇ ODASI	DÖKÜMAN NO	MNT - 01
ÜNİTE ADI	KÜTÜPHANELİ BİLG. MASASI		
ÜNİTE KOD			Sayfa 1 / 2

- Yedek Parçaya ihtiyaç duyduğunuz takdirde, lütfen montaj klavuzunda gösterilmiş olan Parça kodunu belirtiniz.
- WHEN ORDERING EXTRA PARTS , DO NOT FORGET TO MENTION PART CODE



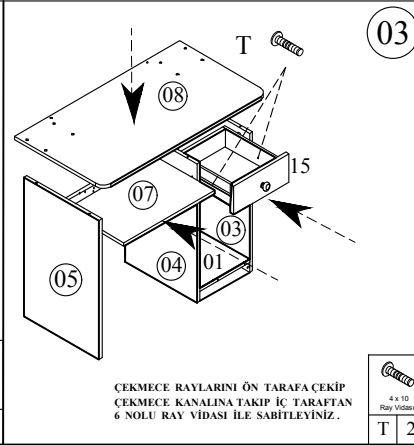

					
I	4	İ	1	A	8
				C	8

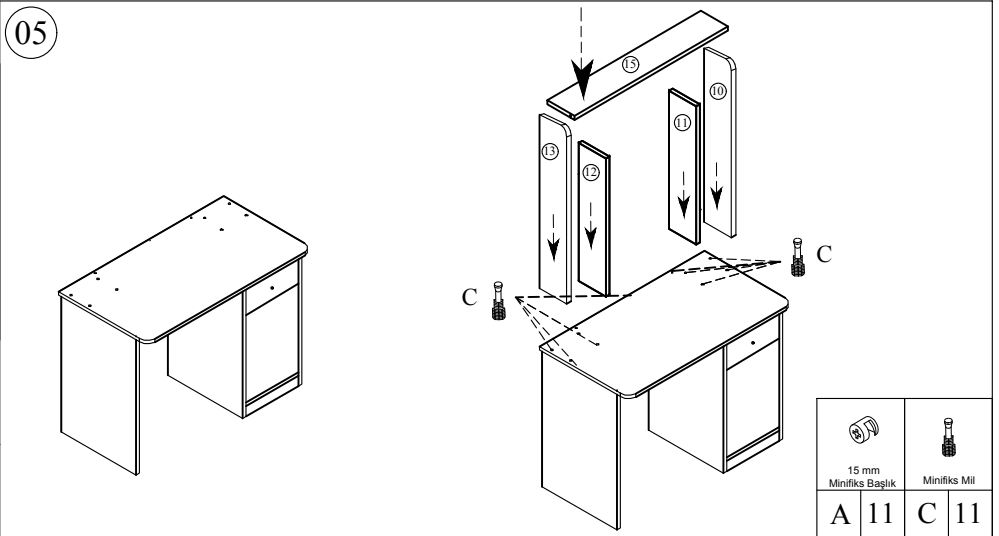

	
T	2

ÇEKMECE RAYLARINI ÖN TARAF ÇEKİP ÇEKMECE KANALINA TAKIP İÇ TARAFTAN 6 NOLU RAY VIDASI İLE SABİTLEYİNİZ.





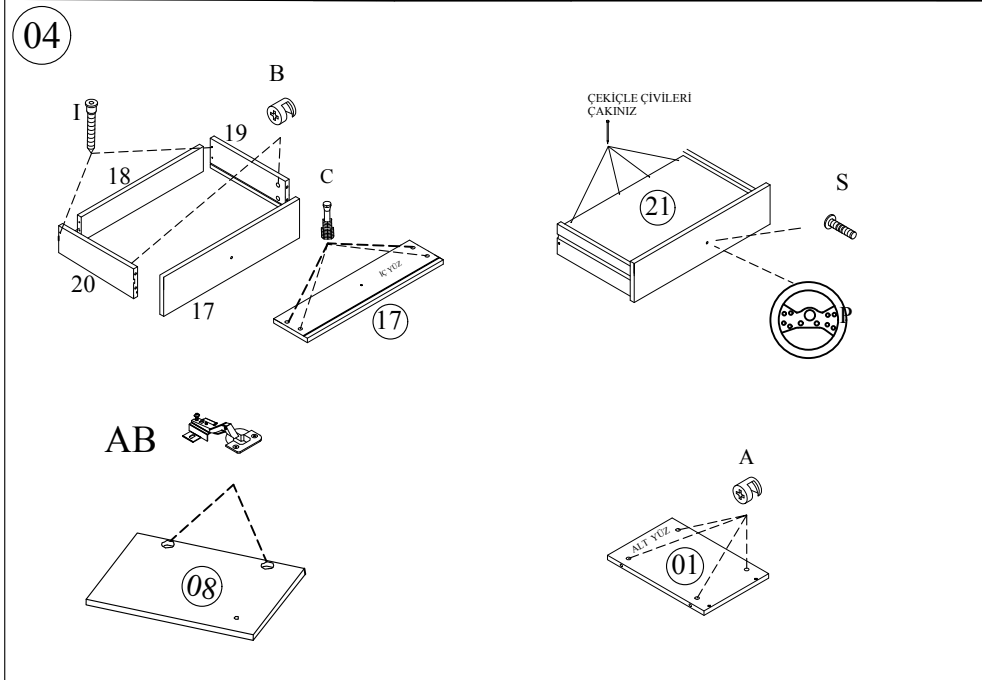



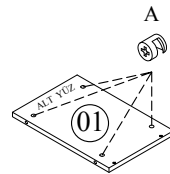
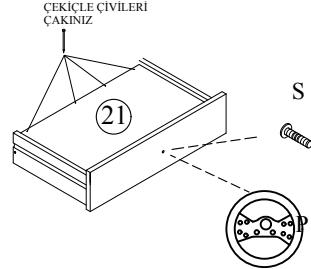
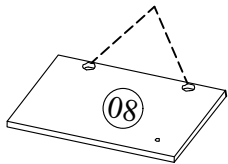

	
A	11
C	11







AB

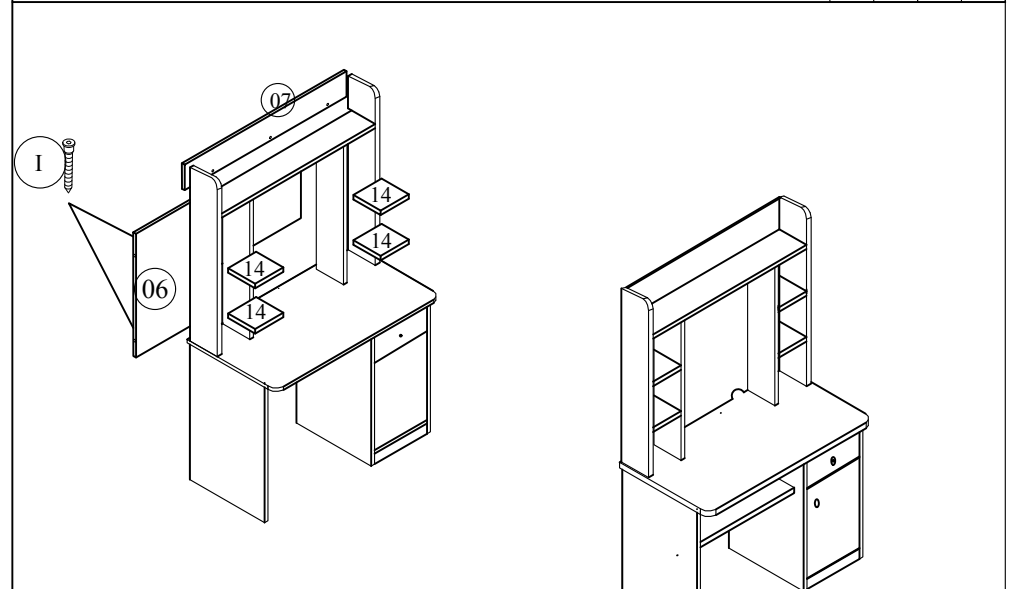

																	
B	4	Ç	2	AD	4	Z	8	AC	4	S	4	BH	2	A	18	C	14



									
AI	8	I	8	İ	1	A	3	C	3

# MONTAJ TALİMATI

MODEL ADI	FORMULA-RALLY GENÇ ODASI	DÖKÜMAN NO	MNT - 02
ÜNİTE ADI	KÜTÜPHANELİ BİLG. MASASI		
ÜNİTE KOD			Sayfa 2 / 2