

- Yedek Parçaya ihtiyaç duyduğunuz takdirde, lütfen montaj klavuzunda gösterilmiş olan Parça kodunu belirtiniz.
- WHEN ORDERING EXTRA PARTS , DO NOT FORGET TO MENTION PART CODE

1

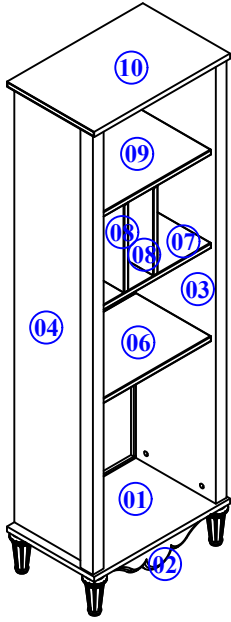

NO PARÇA ADI

- 01 - ALT TABLA
 02 - ON TAC
 03 - SAĞ YAN
 04 - SOL YAN
 05 - ARKALIK
 06 - ALT RAF
 07 - ORTA RAF
 08 - DİK RAFLAR
 09 - ÜST RAF
 10 - ÜST TABLA
 11- KAPAK



CEKMECE
KULP VIDASI
4X22

H 1



MINİFİK
BAŞLIK



Minifiks Mil



SÜPER DEVE



PISTONLU SÜPER DEVE



RAFİXS



VIDA 4x 18



ALYAN VIDA



CEKMECE
KULPU



ARKALIK
SABİTLEME

A 18

B 18

C 1

CA 1

E 8

D 34

AL 6

F 1

K 8

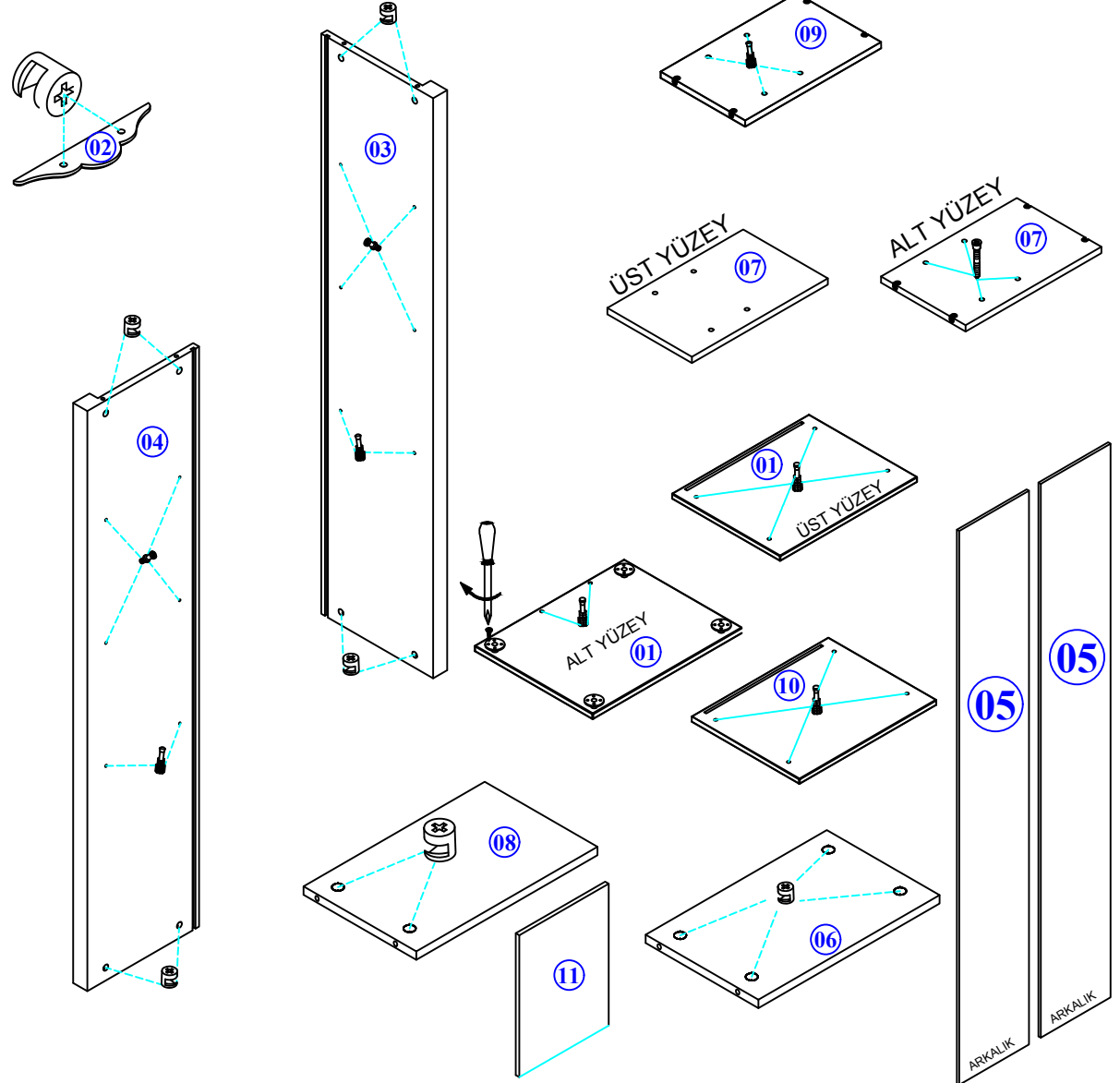

MONTAJ TALİMATI

MODEL ADI	NİLİFER GENÇ ODASI TAKIMI	DÖKÜMAN NO	MNT 1
MODÜL ADI	KİTAPLIK		
			Sayfa 1 / 2

- Yedek Parçaya ihtiyaç duyduğunuz takdirde, lütfen montaj klavuzunda gösterilmiş olan Parça kodunu belirtiniz.
- WHEN ORDERING EXTRA PARTS , DO NOT FORGET TO MENTION PART CODE

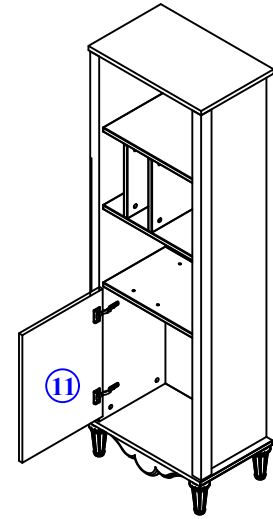
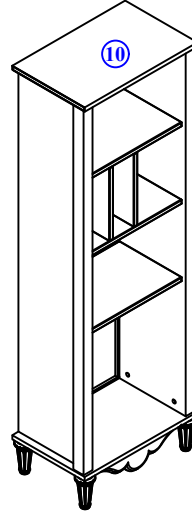
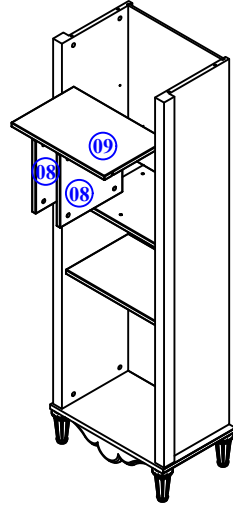
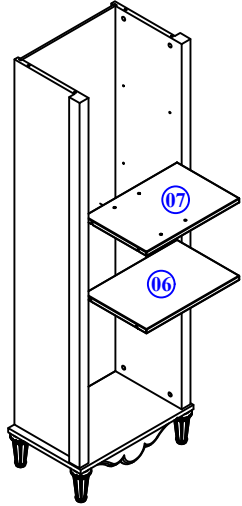
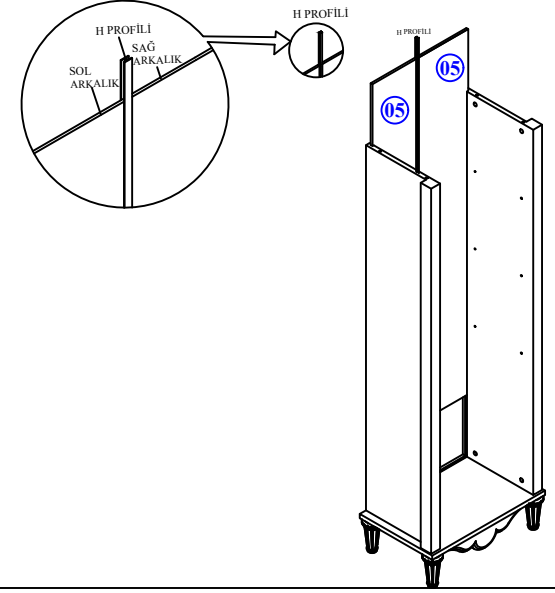
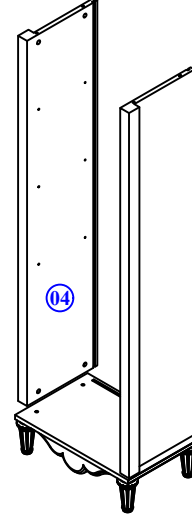
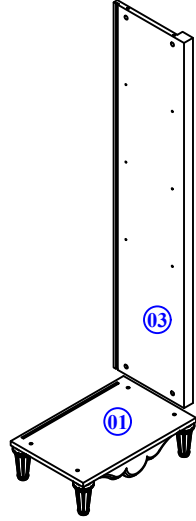
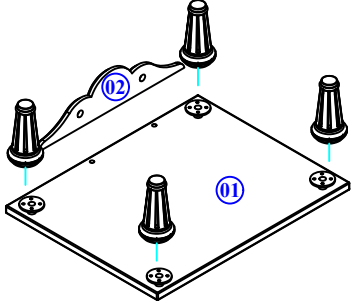

KİTAPLIĞINIZ KULLANIMA HAZIRDIR.
İYİ GÜNLERDE KULLANINIZ...

2

MONTAJ TALİMATI

MODEL ADI
ÜNİTE ADI
ÜNİTE KOD

NİLİFER GENÇ ODASI TAKIMI
KİTAPLIK

DÖKÜMAN NO

MNT - 02

Sayfa 2 / 2